

JOINSCAN LEDs

∅ 3.0 mm 3PINs DUAL COLOR CLEAR TYPE LED LAMP	
MODEL NO.	L305CC
EMITTING COLOR	RED / GREEN
DICE	GaAsp/GaP / GaP
LENS	CLEAR TYPE

ABSOLUTE MAXIMUM RATINGS (最大極限值)			
TA = 25 °C			
PARAMETER	SYMBOL	RATING	UNIT
D1 RED POWER DISSIPATION	P AD	40.0	mW
D2 GREEN POWER DISSIPATION	P AD	44.0	mW
DERATING LINEAR FROM 25 °C		0.27	m / °C
D1 RED CONTINUOUS FORWARD CURRENT	I AF	20.0	mA
D2 GREEN CONTINUOUS FORWARD CURRENT	I AF	20.0	mA
PEAK FORWARD CURRENT (DUTY CYCLE 1 / 10 , 10KHZ)	I PF	90.0	mA
REVERSE VOLTAGE	V R	5.0	V
OPERATING TEMPERATURE	T OPR	-25 °C TO + 85 °C	
STORAGE TEMPERATURE	T STG	-25 °C TO + 85 °C	
SOLDER TEMPERATURE 1/16 INCH BELOW SEATING PLANE FOR 5 SECONDS AT 230 °C OR 3 SECONDS AT 250 °C			

D1 RED ELECTRO - OPTICAL CHARACTERISTICS (電性)						
TA = 25 °C						
PARAMETER	SYMBOL	CONDITION	MIN	TYP	MAX	UNIT
FORWARD VOLTAGE	V F	I F = 20mA	—	1.8	—	V
LUMINOUS INTENSITY	I V	I F = 20mA	—	50	—	mcd
PEAK EMISSION WAVELENGTH	λP	I F = 20mA	—	635	—	nm
REVERSE CURRENT	I R	VR = 5V	—	—	100	μA

D2 GREEN ELECTRO - OPTICAL CHARACTERISTICS (電性)						
TA = 25 °C						
PARAMETER	SYMBOL	CONDITION	MIN	TYP	MAX	UNIT
FORWARD VOLTAGE	V F	I F = 20mA	—	2.2	—	V
LUMINOUS INTENSITY	I V	I F = 20mA	—	50	—	mcd
PEAK EMISSION WAVELENGTH	λP	I F = 20mA	—	570	—	nm
REVERSE CURRENT	I R	VR = 5V	—	—	100	μA

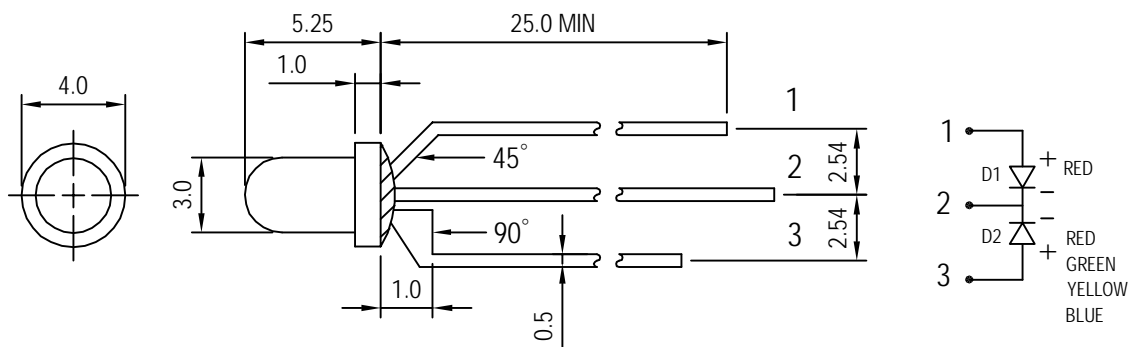

UNIT : mm
TOLERANCE : ± 0.2mm
REV : B